

# ESB201

## Inrush Current Limiter, Inrush Current Protection

For capacitive loads, 115Vac/230Vac 16A, 16 ⅓ Hz – 440Hz, - 20°C ... +45/+55°C

### Short Specification:

- Peak- / R.M.S. inrush current limiter
- 90-132Vac / 184-264Vac, 16A continuous
- Very 35mm low profile housing IP40
- Spring-type terminals 6mm<sup>2</sup> / 10AWG
- Integrated bypass relay
- Capacitive load 6000uF up to 10.000uF
- Integrated thermal protection
- IP40 UL94V-0 ABS-PA765 case
- EN62368-1, EN55032 class B

The ESB is a budget-priced inrush peak current limiter for high loads in LED-applications, complex automation systems and in the machine building. The ESB201 offers effective and interference free operation with capacitive loads. It is simple to integrate into existing equipment. The ESB201 is self-powering and does not require an external power supply.

## 16 ⅓ Hz – 440Hz

**No simple NTC-solution! It allows to reduce cabling sections and to install fast circuit breakers. 100% protection from tripping pre-installed circuit breakers or burning relay and line switch contacts.**



### Technical Table

Model	ESB201.LED.230VAC	ESB201.LED.115VAC
Peak Current Limiting $\pm 6\%$	48A	43A
R.M.S Current Limiting $\pm 6\%$	33,9A	30,4A
Maximum Allowed Capacitive Load	6.000uF	10.000uF
Limiting Time (T <sub>on</sub> Power On)	300ms ( $\pm 50$ ms)	300ms ( $\pm 50$ ms)
Release Time (T <sub>off</sub> Low Voltage)	550ms ( $\pm 50$ ms)	550ms ( $\pm 50$ ms)
Limiting Interval (T <sub>interval</sub> for AC <sub>cont.</sub> )	$\geq 900$ ms	$\geq 900$ ms
Quickest advisable Circuit breaker at 30°C	B13A	A16A B13A Z16A
AC Input Range	184-264Vac	90-132Vac
AC Continuous Input Range	230Vac	115Vac
Line Frequency	16 ½ Hz – 440Hz	16 ½ Hz – 440Hz
Switch-On Voltage	144Vac	79Vac
AC Lower Margin	52Vac (AC dump / drop out voltage)	28Vac (AC dump / drop out voltage)
AC Current	16A continuous load current	
Power Supply	No external power supply required, item is self-powering	
Power consumption	2,2W @ 115Vac / 1,1W @ 230Vac	
Limiting Cycles	Between each limiting action shall be a break of 20 sec., to let the device cool down until the next limiting starts	
Internal Protection	Thermal fuse protects from overheat & fire	
Cooling	Natural convection	
Operation Temp.	Ambient temperature -40°C ... +45°C continuous, +55°C short time	
Storage Temp.	-40°C ... +85°C for 2 years	
EMI	EN55032 class B, EN61000-6-3	
EMS	EN61000-6-2	
Safety Norms	EN61010-1, EN61010-2-201, EN62368-1, EN60950-1	
Safety Class	Class II	
ROHS conformity	ROHS Directive 2011/65/EU	
REACH conformity	REACH Directive 1907/2006	
MTBF Calculation	300.000h (IEC/EN61709, Siemens SN29500)	
MTTF Calculation	384.000h (+30°C) (IEC/EN61709, Siemens SN29500)	
Humidity	95% (+25°C) not condensing	
Pollution Degree	2 (IEC/EN50178)	
Environmental	Thermal environment 3K3, mechanics 3M4 (IEC/EN60721)	
Altitude max.	4000m (13123 ft.) above sea level	
Dimensions (WxHxD)	260x35,4x23,5mm	
Housing	UL94V-0 IP40 ABS (PA765) plastic housing; IP40 must use the equipped grommets	
Weight	0,2kg / 0,44lbs	
Connections	Spring-type terminal solid max. 0,18...6mm <sup>2</sup> 26...10AWG according with IEC/EN60664-1, IEC/EN61984 Use copper conductors only. Wire stripping length 7mm. Tightening torque per terminal block is 0.5 - 0.6 Nm / 4.5 - 5.3 lbf-in	
Cable Strain Relief	6...10mm integrated into the clamp covers	

### General Description

The CAMTEC ESB201-series are the 2nd generation and cost-effective inrush current limiters. The limiters are made for 115/230Vac 16A networks. The line frequency range is 16½Hz – 440Hz. The ESB201-Limiter shall be located between the line-switcher/contactator and the load (Fig.1). The ESB-models are designed for capacitive loads (not for inductive loads like coils/transformers, not for AC-motors and not for DC-voltage application). In the moment of switching-on the system the inrush current of the installed load will be limited for the defined time T<sub>on</sub> (Fig.4). Independent from the previous inrush level; the current limiting is always strict. After T<sub>on</sub> elapses the current limiting circuit of the ESB201 will be bypassed. Then the load is directly connected to the AC. The electrical network can be stressed with current loads as normal. If an AC dump overshoots the defined time T<sub>off</sub>, it will be detected by the ESB201 (Fig.5). As soon as the AC recovers the inrush will be limited, again (Fig.2 & 3). The ESB201-models provide an internal temperature control. In case of a failure the device shuts down to safely prevent from overheating or fire.

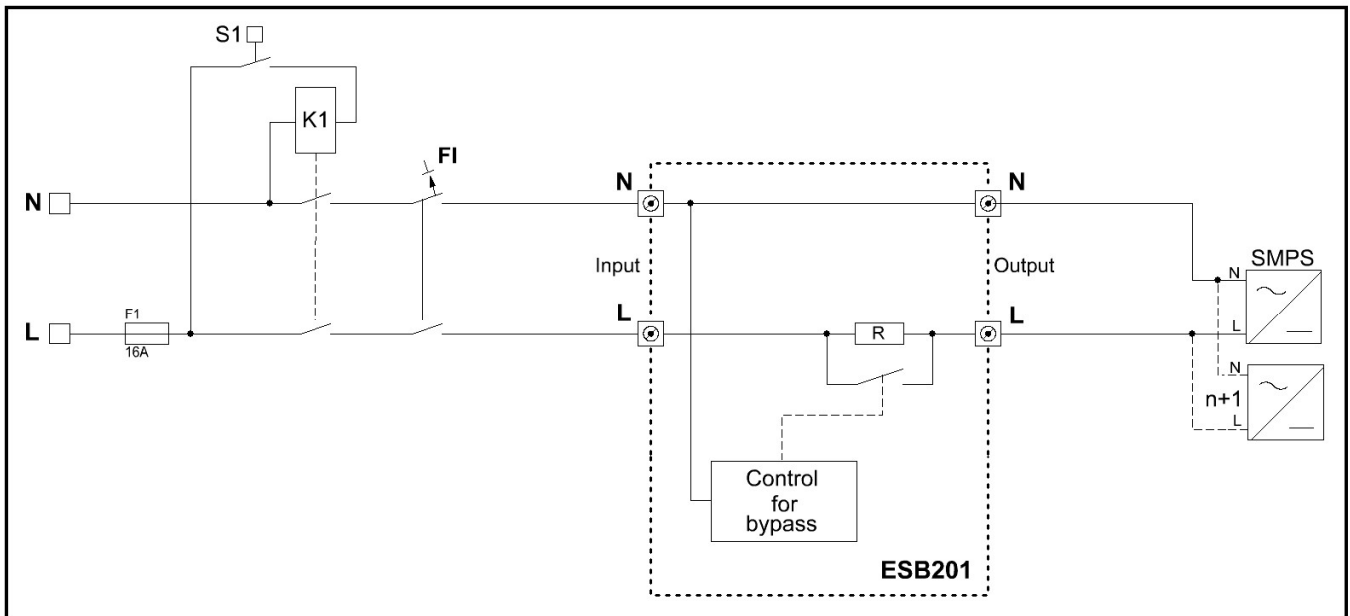

(Fig.1)

### Field Applications

The ESB201 limiter allows connecting much more capacitive loads (e.g. LED-power supply / LED-driver) to a pre-installed circuit breaker CB (Fig.1). The ESB avoids that the MCB will be tripped. This occurs independent to the objective initial current. The result is that the number of A.C. branch lines and the pre-installed MCB can be reduced dramatically. Installation cost exhibit a sustained decline. Alternatively, the cross section of the branch lines can be reduced when using smaller and faster responding circuit breakers. The cost saving from copper is essential. Sensitive AC networks can be fused safer (e.g. Traffic Control Systems, Street-Lighting, Parking Lots and Tunnels). When the ESB201 is installed correctly, the neutral wire (N) is looped trough (Fig.1). The inrush protection circuit always acts to the line conductor. The load relates to the AC in such a way that a circuit breaker or an earth-leakage-trip works within the limits of the legal rules. This fact is also applied while the limiting circuit acts. The ESB201 is designed for capacitive loads, only. The ESB201 cannot be used together with transformers, coils, AC-motors & drives, heaters, ohmic load, or with DC-voltage at all.

### Models ESB201.LED with 115Vac & 230Vac

The ESB201 LED-types are the universal inrush current limiters. The concept design is made to construct optimized A.C. networks in the building automation and in the lighting sector. Tripping the installed circuit breaker will be effectively prevented. The inrush limiting time is adjusted to the values of a typical LED switch mode power supply or LED-driver. The connectable load capacity is such as high, that even in the extremes cases it is rather impossible to exceed it in a 16A network. Installed contactors will be relieved and their lifetimes will considerable increase. To protect the installed relay in a controlled DALI-/DMX-Multiplexer we advise to use the ESB201.23 for a 16A relay or the ESB201.16 for a smaller relay. Note that the ESB201 is not designed to operate together with gas induction lamps or other conventional lighting device. The ESB201 is designed for capacitive loads, only.

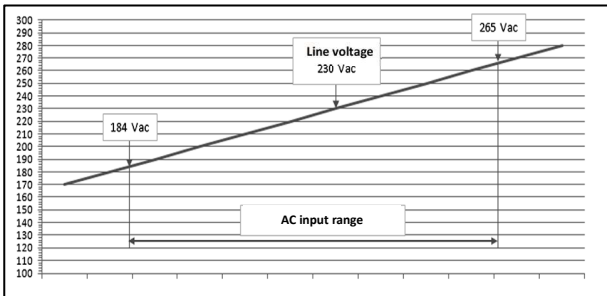

(Fig.2 operating range 230Vac)

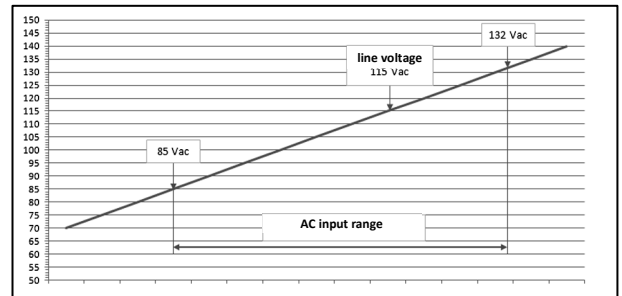

(Fig.3 operating range 115Vac)

### Design-In of the ESB201 into A/C networks

The ESB201 models are the precise inrush current limiter with an overall tolerance of  $\pm 6\%$  of the face value. For the dimension of an upstream connected circuit breaker the R.M.S is the key value of the inrush current, not the peak current. The thermal trigger point will not be met, even while using an extreme fast CB. All-dominant is the magnetic trigger current. By using the empirical formula  $I_{(peak)} \times 0,707^{(factor)} = I_{(r.m.s.)}$  the tripping current can be defined exact. Bear in mind that all the higher the inrush current is, all the faster the input capacitor of several connected switch mode power supplies will be loaded. Deduced by this fact we can say that within a 230V 16A A/C network the right selection for a MCB B16A is the ESB201.LED.230VAC. The technical table on page 2 shows the R.M.S value of all the ESB201 types and models.

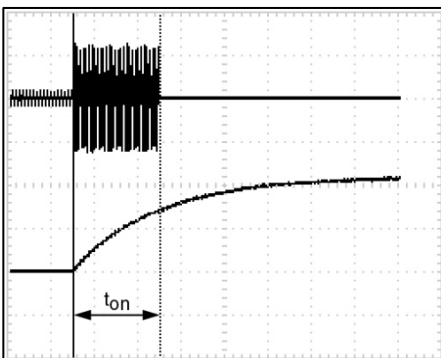

(Fig.4 limiting time  $T_{on}$ )

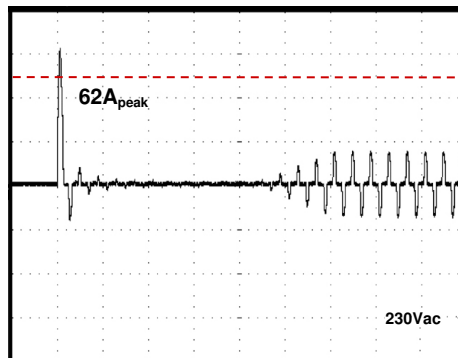

(Fig.5 AC dump detection  $T_{off}$ )

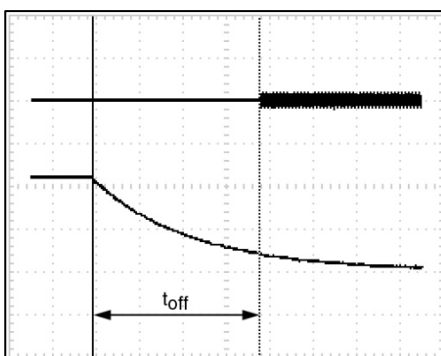

(Fig.6 AC dump detection  $T_{off}$ )

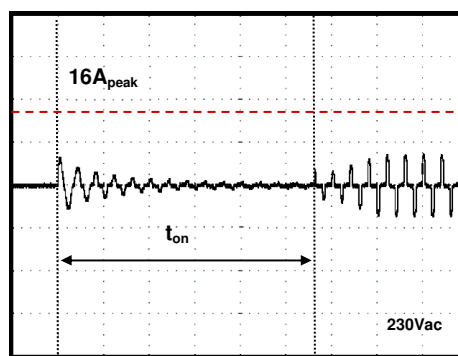

(Fig.7 inrush with ESB201)

### Fig.6 and Fig.7

Fig.6 and Fig.7 show the typical start behavior of a NTC protected sample switch mode power supply. The used test item is a switch mode power supply.

The peak current recordings show the precise limiting of the inrush from formerly  $62A_{peak}$  to  $16A_{peak}$ . The corresponding R.M.S level, that is responsible for the magnetic tripping of the circuit breaker (MCB), is marked down by factor 0,707. After the time  $T_{on}$  elapsed it is identified that the power supply starts neatly into the continuous operation mode. Now the current is absorbed pulse-shaped from the AC supply. In detail the full load R.M.S current consumption level of the sample power supply hits  $9,8A @ 230Vac$ .

### Mechanics

IP40 housing (material ABS PA-765 with UL94V-0) and clamp covers contact protection. The dimensions of the ESB201 allow easy fit into lighting channels of LED-downlights. IP40 must use the equipped grommets at the cable entries.

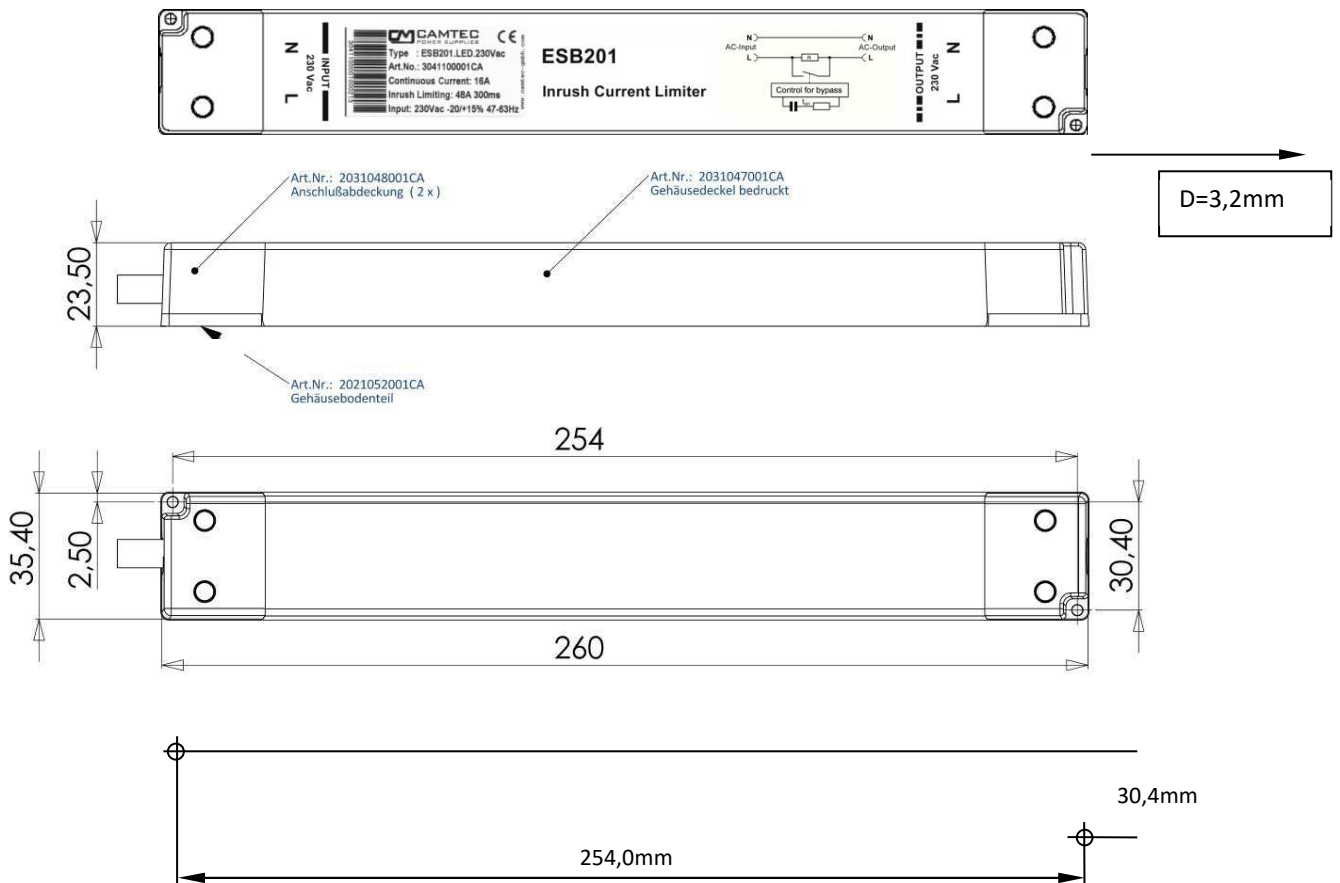

## Connections

### Clamping Yoke Connector Specifications

	Input / Output connections
Tightening torque min. – max.	0,5 – 0,6Nm (blade 1,0x5,5 DIN5264 )
Touch-safe protection acc. to DIN VDE 0470	IP20 plugged/ IP10 unplugged
Clamping range, min. – max.	0,18 – 6mm <sup>2</sup> / AWG26 – AWG10
Solid, H05(07) V-U min. – max.	0,18 – 6mm <sup>2</sup>
Stranded, H05(07) V-U min. – max.	0,22 – 4 mm <sup>2</sup>
w. plastic collar ferrule, DIN 46228 pt 4 min. – max.	0,5 – 2,5mm <sup>2</sup>
w. wire end ferrule, DIN 46228 pt 1, min. – max.	0,5 – 4mm <sup>2</sup>
Plug gauge in accordance with EN 60999 a x b; ø	3,6 x 3,1mm; 2,7mm
Pitch (P)	9,52mm

Wire Stripping Length (fine wired)		
Nominal Cross Section	Wire End Ferrule	Stripping Length
0,5mm <sup>2</sup>	H0,5/6	6mm
0,75mm <sup>2</sup>	H0,75/6	6mm
1,0mm <sup>2</sup>	H1,0/6	6mm
2,5mm <sup>2</sup>	H2,5/7	7mm
4,0mm <sup>2</sup>	H4,0/7	7mm

The length of ferrules is to be chosen depending on the rated voltage. The outside diameter of the plastic collar should not be larger than the pitch (P)

Mounting Instructions				
Follow the above mounting restrictions to allow maximum lifetime of the product and to prevent from tripping the internal temperature protection fuse. The ESB201 is an active device. The distance between an ESB201 and the next active or temperature sensitive device shall be 17,5mm or larger. The power consumption of the device is constant at continuous operation (2,2W @ 115Vac / 1,1W @ 230Vac). Make sure that the ventilation holes below and above the unit are not blocked to allow free air convection.				
Operation Temperature	Ambient Temperature	ESB201, 115Vac, AC 16A current	IEC EN62368-1 / IEC EN60950-1	-40°C ... +45°C
		ESB201, 230Vac, AC 10A current	IEC EN62368-1 / IEC EN60950-1	-40°C ... +55°C
		ESB201, 230Vac, AC 16A current	IEC EN62368-1 / IEC EN60950-1	-40°C ... +45°C

Table of the standards					
Product Code	Article Number	IEC / EN 62368-1	IEC / EN 61010-1	IEC / EN 61010-2-201	IEC / EN 60950-1
ESB201.LED.230VAC(R2)	3041081005CA	Yes	Yes	Yes	Yes
ESB201.LED.115VAC(R2)	3041081006CA	Yes	Yes	Yes	Yes

**Safety regulations: Please read these instructions completely before using the equipment. Keep these instructions on to hand. The device may only be installed by trained specialist staff.**

#### Installation:

- 1) The device is designed for devices and systems that meet the standard requirements for hazardous voltages, power, and fire prevention.
- 2.) Installation and service only by trained persons. The AC power must be switched off. The work is to be labelled; accidental reconnection of the system must be prevented.
- 3.) Opening the device, its modification, loosening bolts, or operation outside the specified herein specification or in an unsuitable environment, has the immediate loss of warranty to follow. We disclaim any responsibility for any resulting damage to persons or things.
- 4.) Note: The device must not be operated without an upstream circuit breaker (CB). The CB must not be larger than 16A.

#### Warning:

**Non-compliance these warnings can result in fire and serious injury or death.**

1. Before connecting the device to the AC network, make wires free of voltage and assure accidentally switch on.
2. Allow neat and professional cabling.
3. Never open nor try to repair the unit. Inside are dangerous voltages that can cause electrical shock hazard.
4. Avoid metal pieces or other conductive material to fall into the item.
5. Do not operate the device in damp or wet conditions
6. Do not operate the unit under EX-conditions.
7. Do not operate the unit with then capacitive load



<p><b>English Installation instruction</b></p>	<p><b>Read this first!</b> Before operating this device, please read this manual thoroughly and retain this manual for future reference! This device may only be installed and put into operation by qualified personnel. If damage or malfunction should occur during operation, immediately turn power off and send device to the factory for inspection. The device does not contain serviceable parts. The information presented in this document is believed to be accurate and reliable and may change without notice. For any clarifications, the English translation will be used.</p> <p><b>WARNING Risk of electrical shock, fire, personal injury, or death:</b></p> <ul style="list-style-type: none"> <li>- Turn power off before working on the device. Protect against inadvertent re-powering.</li> <li>- Do not open, modify, or repair the device.</li> <li>- Use caution to prevent any foreign objects from entering the housing.</li> <li>- Do not use in wet locations or in areas where moisture or condensation can be expected.</li> <li>- Do not touch during power-on and immediately after power-off. Hot surfaces may cause burns.</li> </ul>
<p><b>Deutsch Installations- anweisung</b></p>	<p><b>Vor der Inbetriebnahme lesen!</b> Bitte lesen Sie diese Warnungen und Hinweise sorgfältig durch, bevor Sie das Gerät in Betrieb nehmen. Bewahren Sie die Anleitung zum Nachlesen auf. Das Gerät darf nur durch fachkundiges und qualifiziertes Personal installiert werden. Bei Funktionsstörungen oder Beschädigungen schalten Sie sofort die Versorgungsspannung ab und senden das Gerät zur Überprüfung ins Werk. Das Gerät beinhaltet keine Servicebauteile. Die angegebenen Daten dienen allein der Produktbeschreibung und sind nicht als zugesicherte Eigenschaften im Rechtsinne aufzufassen. Im Zweifelsfall gilt der englische Text.</p> <p><b>WARNUNG Missachtung nachfolgender Punkte kann einen elektrischen Schlag, Brände, schwere Unfälle oder Tod zur Folge haben:</b></p> <ul style="list-style-type: none"> <li>- Schalten Sie die Eingangsspannung vor Installations-, Wartungs- oder Änderungsarbeiten ab und sichern Sie diese gegen unbeabsichtigtes Wiedereinschalten.</li> <li>- Führen Sie keine Änderungen oder Reparaturversuche am Gerät durch. Gerät nicht öffnen!</li> <li>- Verhindern Sie das Eindringen von Fremdkörpern, wie z.B. Büroklammern und Metallteilen.</li> <li>- Betreiben Sie das Gerät nicht in feuchter Umgebung oder in einer Umgebung, bei der mit Betauung oder Kondensation zu rechnen ist.</li> <li>- Gehäuse nicht während des Betriebes oder kurz nach dem Abschalten berühren. Heiße Oberflächen können Verletzungen verursachen.</li> </ul>
<p><b>Français Instruction d'installation</b></p>	<p><b>A lire avant mise sous tension!</b> Veuillez lire ces instructions de montage et d'entretien avant de mettre l'alimentation sous tension. Conservez ce manuel qui vous sera toujours utile. Cette alimentation ne doit être installée que par du personnel qualifié et compétent. En cas de dommage ou dysfonctionnement, coupez immédiatement la tension d'alimentation et retournez l'appareil à l'usine pour vérification! L'alimentation ne contient pas de pièces échangeables Les données indiquées dans ce document servent uniquement à donner une description du produit et n'ont aucune valeur juridique. En cas de divergences, le texte anglais fait foi.</p> <p><b>AVERTISSEMENT Prendre en compte les points suivants, afin d'éviter toute détérioration électrique, incendie, dommage aux personnes ou mort:</b></p> <ul style="list-style-type: none"> <li>- Mettre l'alimentation hors tension avant toute intervention sur celle-ci et s'assurer qu'il n'y a pas risque de redémarrage.</li> <li>- Ne pas ouvrir, modifier ou réparer l'alimentation.</li> <li>- Veiller à ce qu'aucun objet ne rentre en contact avec l'intérieur de l'alimentation (trombones, pièces métalliques).</li> <li>- Ne pas faire fonctionner l'appareil dans un environnement humide ou dans un environnement où il peut y avoir de la condensation.</li> <li>- Ne pas toucher le carter pendant le fonctionnement ou directement après la mise hors tension. Surface chaude risquant d'entraîner des blessures.</li> </ul>
<p><b>Español Instrucciones de instalación</b></p>	<p><b>Lea primero!</b> Conserve este manual como referencia para futuras consultas. La fuente de alimentación solo puede ser instalada y puesta en funcionamiento por personal cualificado. Por favor lea detenidamente este manual antes de conectar la fuente de alimentación. Si se produce un fallo o mal funcionamiento durante la operación, desconecte inmediatamente la tensión de alimentación. En ambos casos, el equipo debe ser inspeccionado en fábrica. La información presentada en este documento es exacta y fiable en cuanto a la descripción del producto y puede cambiar sin aviso. En casa de duda, prevalece el texto inglés.</p> <p><b>ADVERTENCIA Riesgo de descarga eléctrica, incendio, accidente grave o muerte:</b></p> <ul style="list-style-type: none"> <li>- Desconectar la tensión de red antes de trabajar en la fuente de alimentación. Evite una posible reconexión involuntaria.</li> <li>- No realizar ninguna modificación o reparación de la unidad. No abrir la unidad.</li> <li>- Evitar la introducción en la carcasa de objetos extraños.</li> <li>- No usar el equipo en ambientes húmedos. No operar el equipo en ambientes donde se espere la formación de rocío o condensación.</li> <li>- No tocar durante el funcionamiento ni inmediatamente después del apagado. El calor de la superficie puede causar quemaduras graves.</li> </ul>
<p><b>Italiano Istruzioni di Installazione</b></p>	<p><b>Leggere prima questa parte!</b> Prima di collegare il sistema di alimentazione elettrica si prega di leggere attentamente le seguenti avvertenze. Conservare le istruzioni per la consultazione futura. Il sistema di alimentazione elettrica deve essere installato solo da personale competente e qualificato. Se durante il funzionamento si verificano anomalie o guasti, scollegare immediatamente la tensione di alimentazione. In entrambi i casi è necessario far controllare l'apparecchio dal produttore! I dati sono indicati solo a scopo descrittivo del prodotto e non vanno considerati come caratteristiche garantite dell'apparecchio. In caso di differenze o problemi è valido il testo inglese.</p> <p><b>AVVERTENZA Il mancato rispetto delle seguenti norme può provocare folgorazione elettrica, incendi, gravi incidenti e perfino la morte:</b></p> <p>Prima di eseguire interventi di installazione, di manutenzione o di modifica scollegare la tensione di rete ed adottare tutti i provvedimenti necessari per impedirne il ricollegamento non intenzionale.</p> <ul style="list-style-type: none"> <li>- Non tentare di aprire, di modificare o di riparare da soli l'apparecchio.</li> <li>- Impedire la penetrazione di corpi estranei nell'apparecchio, ad esempio fermagli o altri oggetti metallici.</li> <li>- Non far funzionare l'apparecchio in un ambiente umido. Non far funzionare l'apparecchio in un ambiente soggetto alla formazione di condensa o di rugiada.</li> <li>- Non toccare quando acceso e subito dopo lo spegnimento. La superficie calda può causare scottature.</li> </ul>
<p><b>Português Instruções de instalação</b></p>	<p><b>Leia primeiro!</b> Recomendamos a leitura cuidadosa das seguintes advertências e observações, antes de colocar em funcionamento a fonte de alimentação. Guarde as Instruções para futura consulta, em casos de dúvida. A fonte de alimentação deverá ser instalada apenas por profissionais da área, tecnicamente qualificados. Se por acaso, durante a utilização ocorrer algum defeito de funcionamento ou dano, desligue imediatamente a tensão de alimentação. Em ambos os casos, será necessária uma verificação na Fábrica! Os dados mencionados têm como finalidade somente a descrição do produto, e não devem ser interpretados como propriedades garantidas no sentido jurídico. Em caso de dúvidas aplica-se o texto em inglês.</p> <p><b>ATENÇÃO A não observância ou o incumprimento dos pontos a seguir mencionados, poderá causar uma descarga elétrica, incêndios, acidentes graves ou morte:</b></p> <p>Antes de trabalhos de instalação, manutenção ou modificação, desligue a tensão de alimentação, protegendo-a contra uma nova ligação involuntária.</p> <ul style="list-style-type: none"> <li>- Não efectue nenhuma modificação ou tentativa de reparação no aparelho. Quando necessário contacte o seu distribuidor. Não abra o aparelho.</li> <li>- Proteger a fonte de alimentação contra a introdução inadvertida de corpos metálicos, como por ex., cliques ou outras peças de metal.</li> <li>- Não usar o aparelho em ambientes húmidos. Não usar o aparelho em ambientes propensos a condensações.</li> <li>- Não tocar enquanto estiver em funcionamento, nem após a desligar. A superfície poderá estar quente e provocar lesões.</li> </ul>